

CLIP CODE 2710

6-FINGER

MATING PIN DIAMETER RANGE

0.96-1.3 mm

COMPLIANCY Δ

0.24 mm

MIN. MATING PIN LENGTH

3 mm

CURRENT RATING

8 A

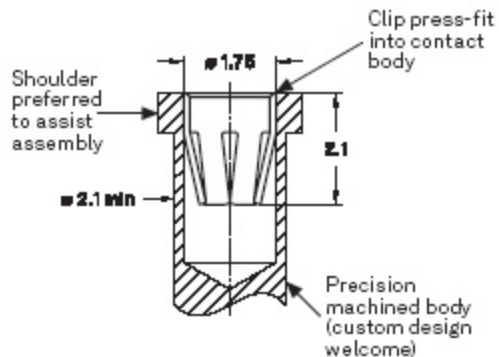

Force [N]

