



preci-dip

DIL SOCKETS

SERIES
299

299-PP-622-10-002101
2.54 mm, Right angle, Solder tail

Right angle DIL Sockets for components to be mounted perpendicularly to the PCB such as displays

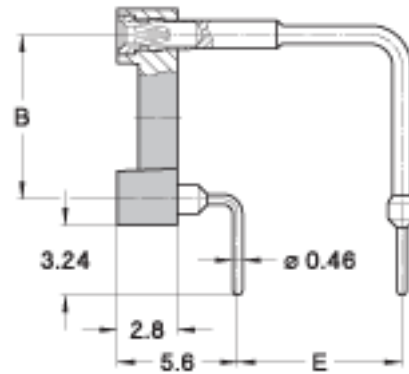

TECHNICAL SPECS.:

Insulator	Black glass filled polyester PCT-GF30-FR
Flammability	UL 94V-O
Sleeve	Brass CuZn36Pb3 (C36000)
Contact	Clip (4 finger): Beryllium copper (C17200)
Accepted pin \varnothing	0.40 to 0.56 mm
Insertion force	2 N typ.
Withdrawal force	1 N typ. (polished steel gauge \varnothing 0.43 mm)
Mechanical life	Min. 100 cycles
Rated current	1 A
Contact resistance	Max. 10 m
Dielectric strength	Min. 1000 V RMS

ORDERING INFORMATION:

PP Plating code	Sleeve	Clip
87	Tin	Gold flash
83	Tin	Gold 0.75 μ m

For complete part number replace XX with the code given below left

ADVANCED INFORMATION:

Order Codes	Poles	A	B	C	D	E	See
299-PP-210-10-001101	10	12.6	5.08	7.6			Fig. 1

299-PP-608-10-002101	8	10.1	15.24	17.7	Fig. 3
299-PP-610-10-002101	10	12.6	15.24	17.7	Fig. 3
299-PP-612-10-002101	12	15.2	15.24	10.1	Fig. 3
299-PP-614-10-002101	14	17.7	15.24	10.1	Fig. 3
299-PP-616-10-002101	16	20.1	15.24	17.7	Fig. 3
299-PP-618-10-002101	18	22.8	15.24	17.7	Fig. 3
299-PP-620-10-002101	20	25.3	15.24	17.7	Fig. 3
299-PP-622-10-002101	22	27.8	15.24	17.7	Fig. 3
299-PP-624-10-002101	24	30.4	15.24	17.7	Fig. 3
299-PP-626-10-002101	26	33.0	15.24	17.7	Fig. 3
299-PP-628-10-002101	28	35.5	15.24	17.7	Fig. 3
299-PP-630-10-002101	30	38.0	15.24	17.7	Fig. 3
299-PP-632-10-002101	32	40.6	15.24	17.7	Fig. 3
299-PP-636-10-002101	36	45.7	15.24	17.7	Fig. 3
299-PP-640-10-002101	40	50.6	15.24	17.7	Fig. 3
299-PP-648-10-002101	48	61.0	15.24	17.7	Fig. 3

TECHNICAL ASSISTANCE

GENERAL SPECIFICATIONS:

The values listed below are general specs applying for PRECI-DIP DIL sockets. Please see individual catalog page for additional and product specific technical data.

Operating temperature range	-55 ... +125 °C
Climatic category (IEC)	55/125/21
Operating humidity range	annual mean 75 %
Max working voltage	100 VRMS/150 VDC

PRECI-DIP sockets are recognized by Underwriters Laboratories Inc. and listed under "Connectors for Use in Data, Signal, Control and Power Applications", File Nr. E174442.

MECHANICAL CHARACTERISTICS:

Clip retention	Min. 40 N (no displacement under axial force applied)
Contact (sleeve / clip) retention	Min. 3.3 N acc. to MIL-DTL-83734, pt 4.6.4.2

ELECTRICAL CHARACTERISTICS:

Insulation resistance between any two adjacent contacts	Min. 10'000 M at 500 V AC
Capacitance between any two adjacent contacts	Max. 1 pF
Air and creepage distances between any two adjacent contacts	Min. 0.6 mm (Min. 0.2 mm FOR SHRINK-DIP SOCKETS)

ENVIRONMENTAL CHARACTERISTICS:

The sockets withstand the following environmental tests without mechanical and electrical defects:

- Dry heat steady state IEC 60512-11-9.11i / 60068-2-2.Bb: 125 °C, 16h
- Damp heat cyclic IEC 60512-11-12.11m / 60068-2-30.Db: 25/55 °C, 90 – 100 %rH, 1 cycle of 24 h
- Cold steady state IEC 60512-11-10.11j / 60068-2-1.A: -55 °C, 2 h
- Thermal shock IEC 60512-11-4.11d / 60068-2-14.Na: -55/125 °C, 5 cycles 30 min
- Sinusoidal vibrations IEC 60512-6-4.6d / 60068-2-6.Fc: 10 to 500 Hz, 10 g, 1 octave/min, 10 cycles for each axis
- Shock IEC 60512-6-3.6c / 60068-2-27.Ea: 50 g, 11 ms, 3 shocks in three axis

During the above two tests no contact interruption >50 ns does appear.

- Solderability J-STD-002A, Test A, 245°C, 5 s solder alloy SnAg3.8Cu0.7
- Resistance to soldering heat J-STD-0020C, 260°C, 20 s
- Moisture sensitivity J-STD-020C level 1
- Resistance to corrosion :
 - 1) Salt spray test IEC 60068-2-11.Ka: 48 h
 - 2) Sulfur dioxide (SO₂) test IEC 60068-2-42 Kc: 96 h at 25 ppm SO₂, 25 °C, 75 %rH
 - 3) Hydrogen sulfide (H₂S) test IEC 60068-2-43 Kd: 96 h at 12 ppm H₂S, 25 °C, 75 %rH

SOLDERLESS COMPLIANT PRESS-FIT CHARACTERISTICS:

PRESS-FIT CHARACTERISTICS MEASURED ACC. TO IEC 60352-5

- Press-in force: 90 N max. (at min. hole dia.) / 65 N typ.
- Push-out force: 30 N min. (at max. hole dia.) / 50 N typ.
- Push-out 3rd cycle: 20 N min. (at max. hole dia.)

PCB HOLE DIMENSIONS

- 2.54 mm grid: Finished hole Ø: 1 + 0.09/-0.06 mm | Drilled hole Ø: 1.15 ± 0.02 mm

PCB HOLE PLATING

- PCB surface finish: Hole plating
- Tin: 5-15 μm tin over min. 25 μm copper
- Copper: min. 25 μm copper
- Gold over nickel: 0.05-0.2 μm gold over 2.5-5 μm nickel over min. 25 μm copper