

CLIP CODE 0210

6-FINGER

MATING PIN DIAMETER RANGE

0.98-1.2 mm

COMPLIANCY Δ

0.22 mm

MIN. MATING PIN LENGTH

3 mm

CURRENT RATING

8A

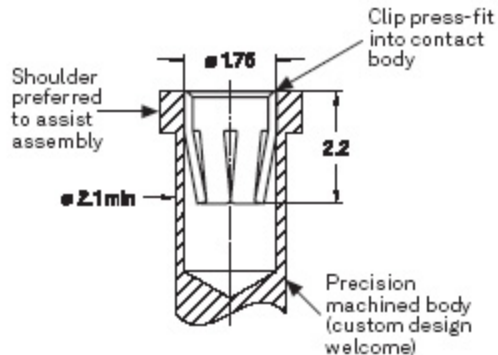

Force [N]

