

CLIP CODE 1310

4-FINGER

MATING PIN DIAMETER RANGE

1.1-1.5 mm

COMPLIANCY Δ

0.35 mm

MIN. MATING PIN LENGTH

4.2 mm

CURRENT RATING

11 A

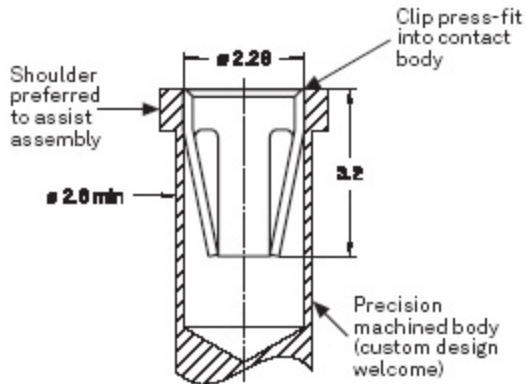

Force [N]

