

# CLIP CODE 3010

4-FINGER

MATING PIN DIA METER RANGE

0.36-0.56 mm

COMPLIANCY  $\Delta$

0.2 mm

MIN. MATING PIN LENGTH

2.4 mm

CURRENT RATING

3A

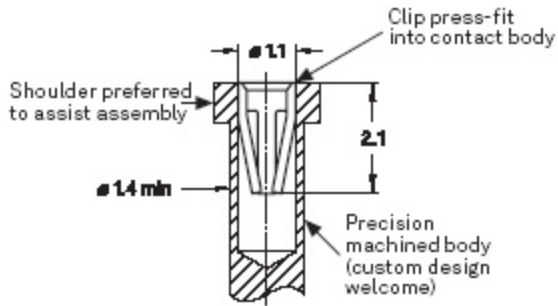

Force [N]

