

CLIP CODE 3020

4-FINGER

MATING PIN DIAMETER RANGE

0.3-0.5 mm

COMPLIANCY Δ

0.2 mm

MIN. MATING PIN LENGTH

2.4 mm

CURRENT RATING

3 A

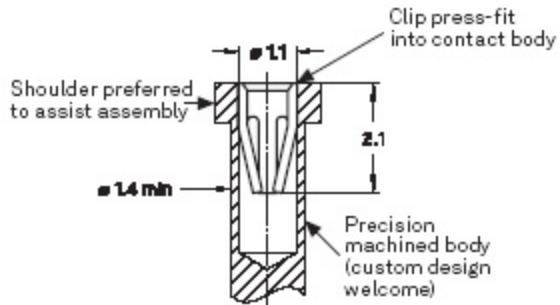

Force [N]

