

CLIP CODE 3110

6-FINGER

MATING PIN DIAMETER RANGE

0.38-0.7 mm

COMPLIANCY Δ

0.3 mm

MIN. MATING PIN LENGTH

2.5 mm

CURRENT RATING

3 A

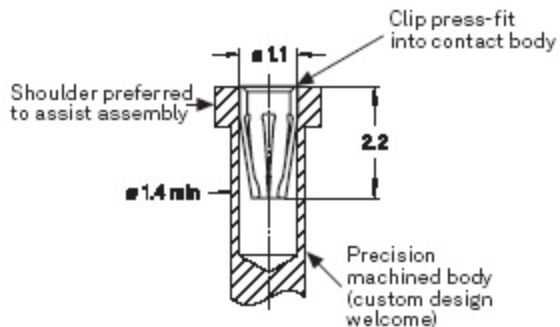

Force [N]

