

CLIP CODE 3920

6-FINGER

MATING PIN DIAMETER RANGE

1.4-1.7 mm

COMPLIANCY Δ

0.25 mm

MIN. MATING PIN LENGTH

3.5 mm

CURRENT RATING

11 A

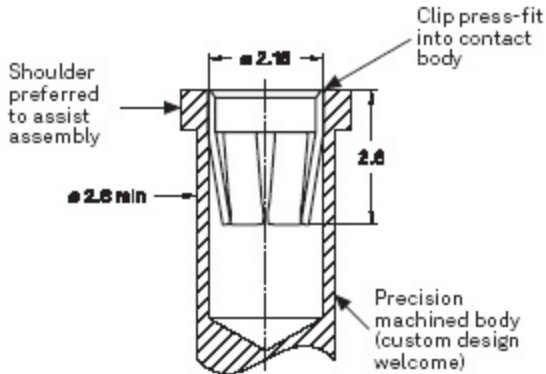

Force [N]

