

# CLIP CODE 4710

6-FINGER

MATING PIN DIAMETER RANGE

0.64-0.92 mm

COMPLIANCY  $\Delta$

0.24 mm

MIN. MATING PIN LENGTH

2.6 mm

CURRENT RATING

5A

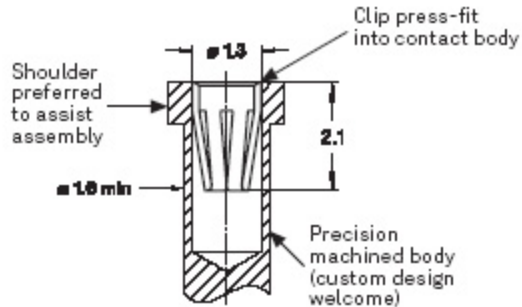

Force [N]

